

## UVS-KO-A ALÜMİNYUM KANATLI AKSİYEL FAN UVS-KO-A ALUMINUM IMPELLIER AXIAL FAN

### KULLANIM ALANLARI / AREAS OF USAGE

- Binalar-Buildings
- Fabrikalar-Factories
- Hastaneler-Hospital
- Restoranlar-Shopping Malls
- Otoparklar-Car Parks



### ÖZELLİKLERİ / SPECIFICATIONS

- Airfoil kesitli alüminyum kanatlar
- Airfoil type aluminum blades
- Ayarlanabilir kanat açısı
- Adjustable pith angle
- Frekans konvertörü ile çalışmaya uygun üç fazlı motorlar
- Three-phase motors suitable to be used with frequency inverter
- Çift devirli motor seçeneği
- Suitable to use with double speed
- -20 °C / 55 °C de sürekli çalışabilme
- Continuously operate on -20 °C / 55 °C
- EN 12101-3 sertifikalı 300 °C / 2h yangın dayanımı
- EN 12101-3 certified 300 °C / 2h free endurance
- İki yönde de çalışabilme özelliği ( Opsiyonel )
- Reversible ( Optional )
- Dış ortamlarda çalışmaya uygun
- Suitable to use in outdoor applications

MODEL	VOLTAJ (V)	FREKANS (Hz)	POWER (kW)	RPM (d/d)	AIRFLOW (Max. Debi) (m³/h)	KORUMA SINIFI (IP)
UVS-KO-A-400	230/380	50	0.37	1400	3500	55
UVS-KO-A-450	230/380	50	0.55	1400	4400	55
UVS-KO-A-500	230/380	50	0.55	1400	6000	55
UVS-KO-A-560	230/380	50	0.75	1400	8200	55
UVS-KO-A-630	230/380	50	1.1	1400	14000	55
UVS-KO-A-710	230/380	50	1.5	1400	20000	55
UVS-KO-A-800/A	230/380	50	2.2	1400	26000	55
UVS-KO-A-800/B	230/380	50	3	1400	32000	55
UVS-KO-A-900/A	380	50	4	1400	40000	55
UVS-KO-A-900/B	380	50	5.5	1400	48000	55
UVS-KO-A-900/C	380	50	11	1400	49000	55
UVS-KO-A-1000/A	380	50	7.5	1400	56000	55
UVS-KO-A-1000/B	380	50	15	1400	65000	55
UVS-KO-A-1000/C	380	50	18.5	1400	73000	55
UVS-KO-A-1120/A	380	50	22	1400	90000	55
UVS-KO-A-1120/B	380	50	30	1400	100000	55

MODEL	Ø A	Ø C	B	T	Y	H
UVS-KO-A-400	400	460	450	304	494	306
UVS-KO-A-450	450	510	450	304	544	346
UVS-KO-A-500	500	560	550	304	544	396
UVS-KO-A-560	560	620	550	294	634	446
UVS-KO-A-630	630	690	600	294	634	496
UVS-KO-A-710	710	790	650	294	634	546
UVS-KO-A-800	800	880	700	384	634	616
UVS-KO-A-900	900	980	800	384	734	686
UVS-KO-A-1000	1000	1080	850	384	834	746
UVS-KO-A-1120	1120	1200	900	-	934	-

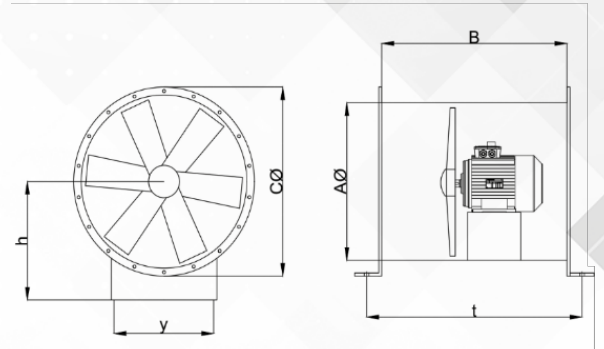

## UVS-KO PERFORMANS GRAFİKLERİ

### UVS-KO PERFORMANCE GRAPHICS

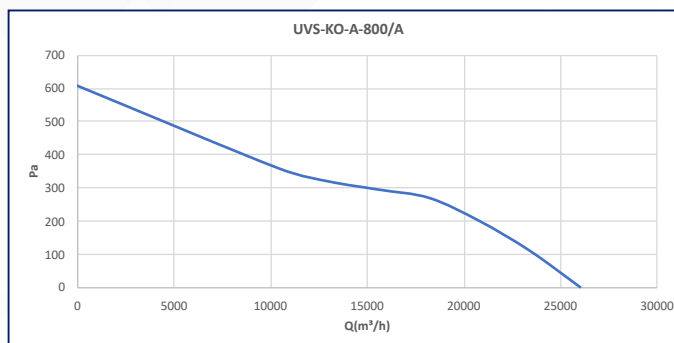
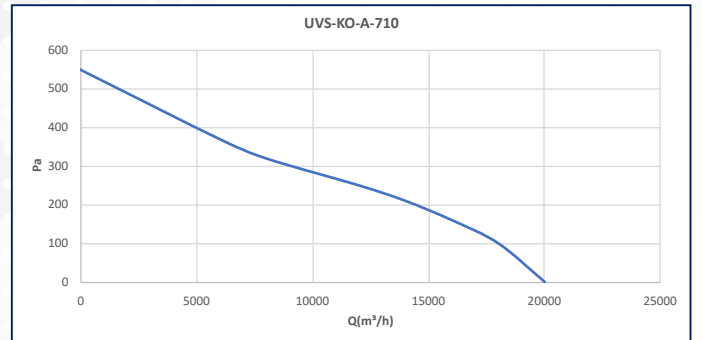
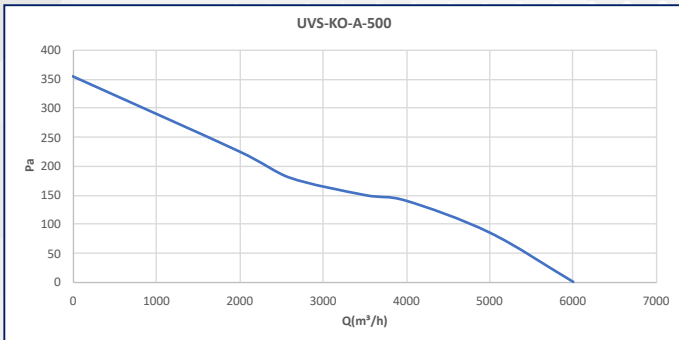
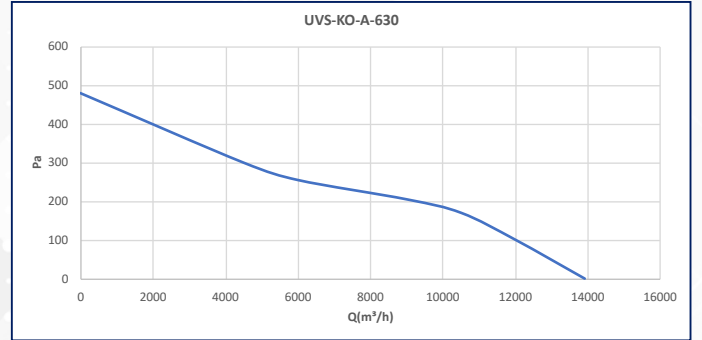
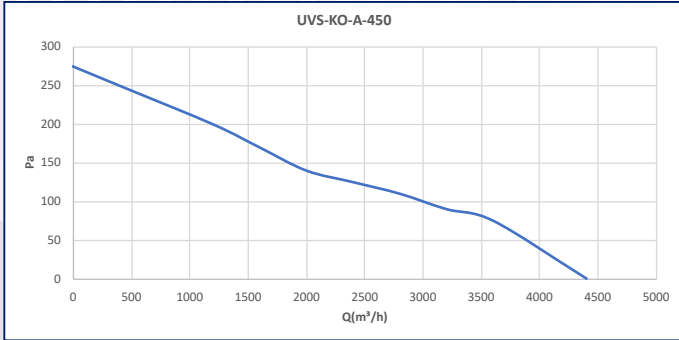
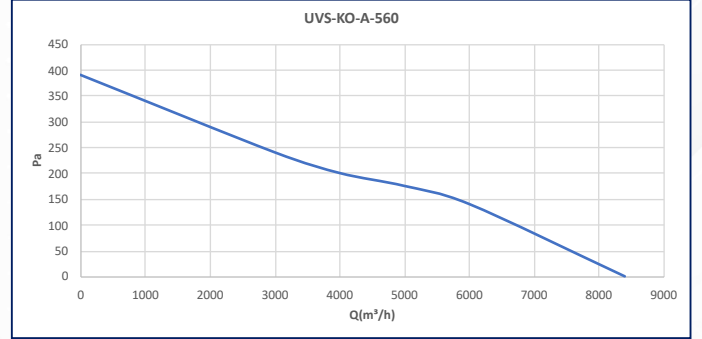
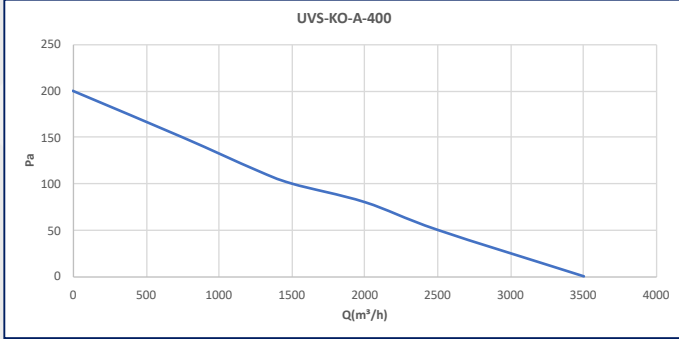

## UVS-KO PERFORMANS GRAFİKLERİ

### UVS-KO PERFORMANCE GRAPHICS

