

UVS-GS ALÇAK BASINÇLI RADYAL FAN

UVS-GS LOW PRESSURE RADIAL FAN



KULLANIM ALANLARI / AREAS OF USAGE

- Yağlı ve tozlu ortamların hava naklinde / Aspiration of clean or slightly dusty air
- Egzost havalandırmasında / Aspiration of exhaust fumes

ÖZELLİKLERİ / SPECIFICATIONS

- Debi / Airflow : 3000 – 50000 m³/h
- Basınç / Pressure : 400 – 1400 Pa
- Geriye eğik seyrek kanatlı / Backward curved impeller
- Direkt akuple veya kayış kasnak tahrikli / Direct coupling or belt driven
- Minimum motor gücüyle , max. kapasite / Minimum engine power – max. capacity

MODEL	VOLTAJ (V)	FREKANS (Hz)	AKIM (A)	POWER (kW)	RPM (d/d)	AIRFLOW (Debi) (m ³ /h)	PRESSURE (Basınç) (Pa)	KORUMA SINIFI (IP)	AĞIRLIK (kg)
UVS-GS320	230/380	50	3.3/1.6	0.55	1450	3500	400	55	78
UVS-GS350A	230/380	50	3.3/1.6	0.55	1450	3800	400	55	78
UVS-GS350B	230/380	50	3.3/1.6	0.75	1450	5000	400	55	78
UVS-GS400A	230/380	50	5.4/1.92	0.75	1450	6000	400	55	91
UVS-GS400B	230/380	50	7.2/2.2	1.1	1450	7000	400	55	98
UVS-GS450A	230/380	50	7.2/2.2	1.1	1450	8000	400	55	98
UVS-GS450B	230/380	50	9.8/3.5	1.5	1450	10000	500	55	104
UVS-GS500A	230/380	50	14/4.9	2.2	1450	10500	600	55	145
UVS-GS500B	230/380	50	14/4.9	2.2	1450	12000	600	55	145
UVS-GS500C	230/380	50	20/6.7	3	1450	13000	600	55	158
UVS-GS550A	380	50	8.4	4	1450	15000	700	55	175
UVS-GS550B	380	50	8.4	4	1450	16000	800	55	175
UVS-GS630A	380	50	11.5	5.5	1450	18000	900	55	225
UVS-GS630B	380	50	16	7.5	1450	20000	900	55	240
UVS-GS630C	380	50	16	7.5	1450	22000	1000	55	240
UVS-GS700A	380	50	21.3	11	1450	26000	1200	55	255
UVS-GS700B	380	50	29.4	15	1450	30000	1300	55	325
UVS-GS800A	380	50	34.5	18.5	1450	40000	1200	55	375
UVS-GS800B	380	50	43	22	1450	50000	1400	55	410

UVS-GS ÖLÇÜ TABLOSU

UVS-GS SIZE TABLE

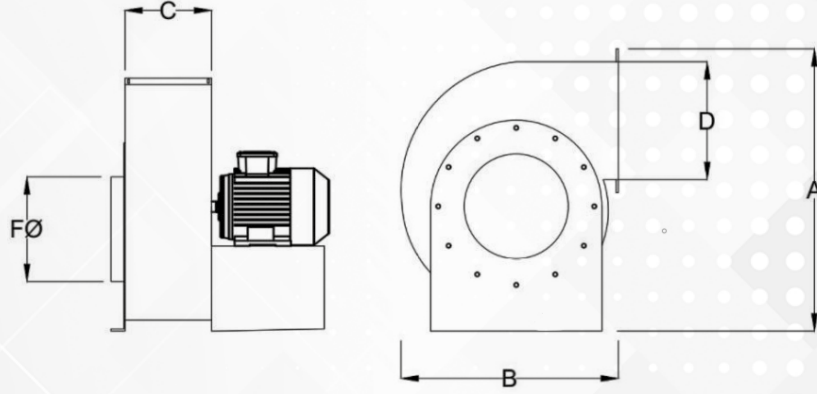

MODEL	A	B	C	D	FØ
UVS-GS320	665	550	200	260	300
UVS-GS350A	720	600	250	280	320
UVS-GS350B	720	600	250	280	320
UVS-GS400A	820	685	270	330	350
UVS-GS400B	820	685	270	330	350
UVS-GS450A	840	700	270	370	400
UVS-GS450B	840	700	270	370	400
UVS-GS500A	850	785	330	410	450
UVS-GS500B	850	785	330	410	450
UVS-GS500C	850	785	330	410	450
UVS-GS550A	950	850	350	450	500
UVS-GS550B	950	850	350	450	500
UVS-GS630A	1070	990	400	520	650
UVS-GS630B	1070	990	400	520	650
UVS-GS630C	1070	990	400	520	650
UVS-GS700A	1240	1130	500	570	750
UVS-GS700B	1240	1130	500	570	750
UVS-GS800A	1425	1215	550	560	900
UVS-GS800B	1425	1215	580	560	900

UVS-GS PERFORMANS TABLOSU / UVS-GSTYPE PERFORMANCE TABLE

MODEL	Pa	300	400	500	600	700	800
UVS-GS320	m ³ /h	4000	3500	1000	-	-	-
UVS-GS350A	m ³ /h	-	3800	2750	-	-	-
UVS-GS350B	m ³ /h	-	5000	3000	-	-	-
UVS-GS400A	m ³ /h	-	6000	4800	2000	-	-
UVS-GS400B	m ³ /h	-	7000	6000	3000	-	-
UVS-GS450A	m ³ /h	-	8000	7200	5400	-	-
UVS-GS450B	m ³ /h	-	-	10000	6500	3000	-
UVS-GS500A	m ³ /h	-	-	-	10500	5000	-
UVS-GS500B	m ³ /h	-	-	-	12000	8500	-
UVS-GS500C	m ³ /h	-	-	-	13000	12000	8000

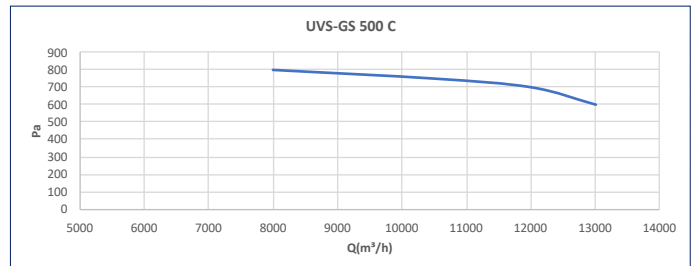
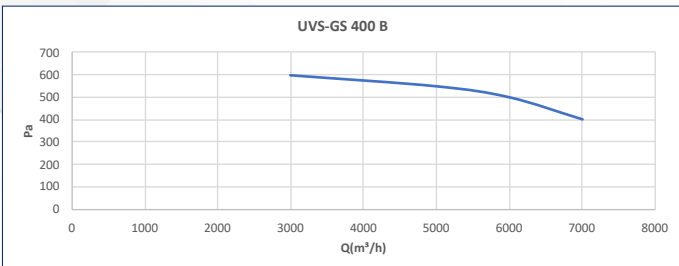
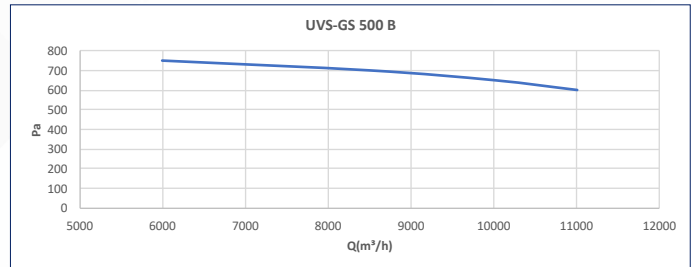
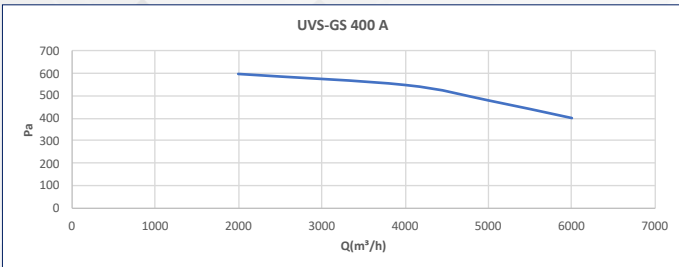
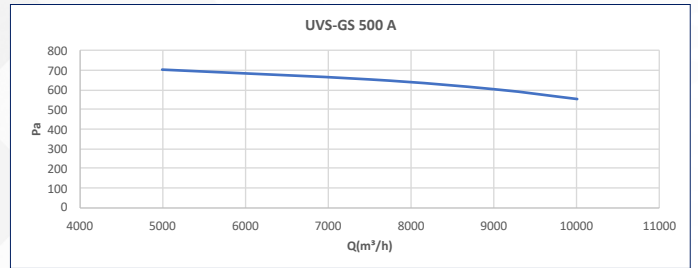
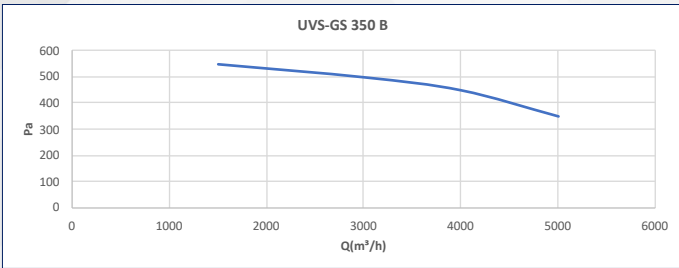
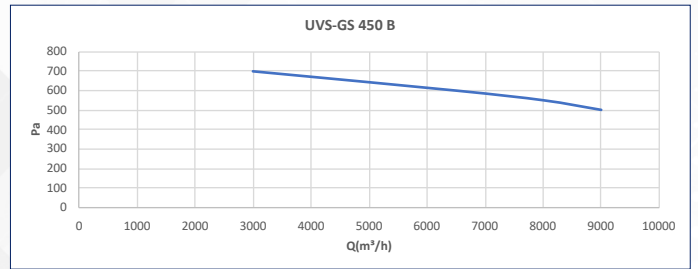
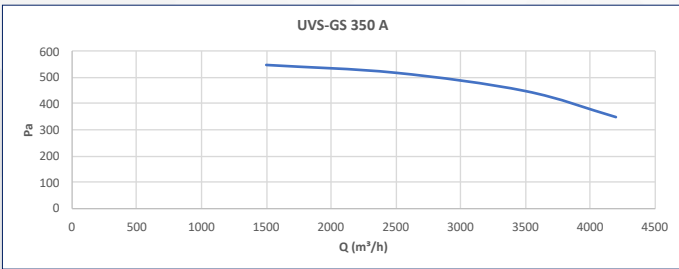
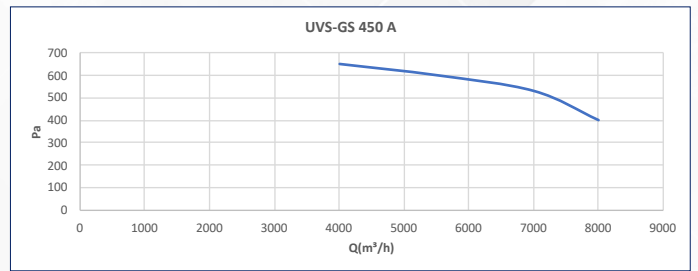
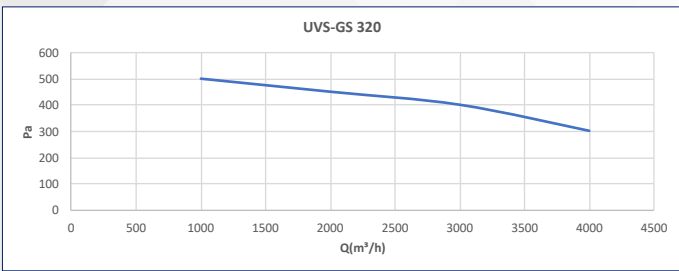

UVS-GS PERFORMANS TABLOSU / UVS-GS TYPE PERFORMANC TABLE

MODEL	Pa	700	800	900	1000	1100	1200	1300	1400	1500	1600	1800
UVS-GS550A	m ³ /h	15000	11600	8000	-	-	-	-	-	-	-	-
UVS-GS550B	m ³ /h	17000	16000	12000	-	-	-	-	-	-	-	-
UVS-GS630A	m ³ /h	20000	19000	18000	14000	8000	-	-	-	-	-	-
UVS-GS630B	m ³ /h	-	22000	20000	17000	13000	-	-	-	-	-	-
UVS-GS630C	m ³ /h	-	-	25000	22000	19000	15000	-	-	-	-	-
UVS-GS700A	m ³ /h	-	-	-	29000	27500	26000	22000	15000	-	-	-
UVS-GS700B	m ³ /h	-	-	-	-	35000	32500	30000	26000	-	-	-
UVS-GS800A	m ³ /h	-	-	-	-	-	40000	38000	36000	35000	30000	-
UVS-GS800B	m ³ /h	-	-	-	-	-	-	55000	52000	50000	47000	35000

